

Characteristic curves of a solar cell (Item No.: P2410901)

Curricular Relevance

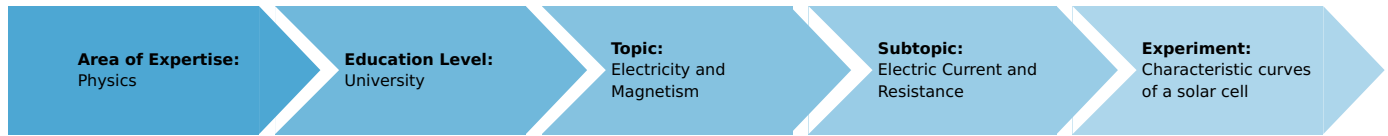

Difficulty



Difficult

Preparation Time



1 Hour

Execution Time



2 Hours

Recommended Group Size



2 Students

Additional Requirements:

Experiment Variations:

Keywords:

semi-conductor, p-n junction, energy-band diagram, Fermi characteristic energy level, diffusion potential, internal resistance, efficiency, photo-conductive effect, acceptors, donors, valence band, conduction band

Overview

Short description

Principle

To measure the current-voltage characteristics of a solar cell at different light intensities, the distance between the light source and the solar cell is varied. Moreover, the dependence of no-load voltage on temperature is determined.

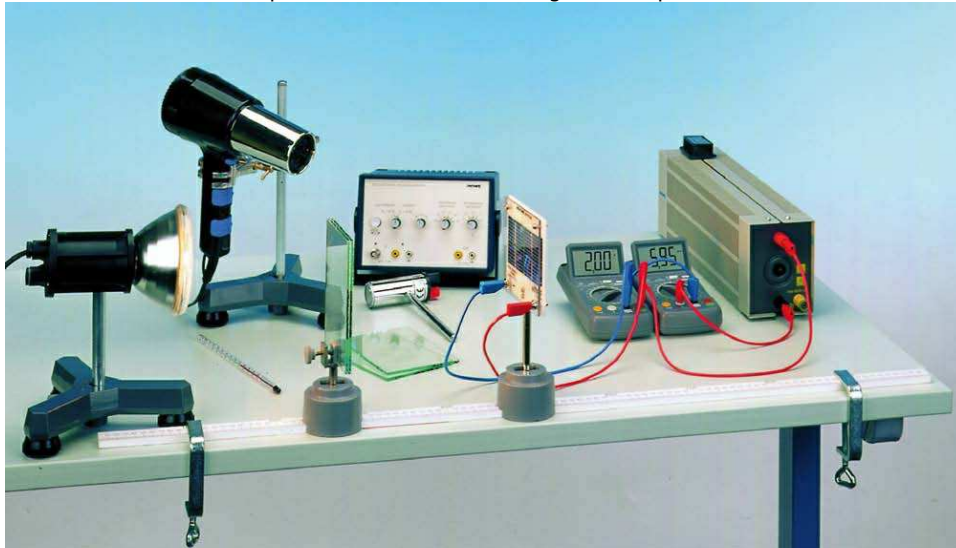

Fig. 1: Experimental set-up of experiment P2410901.

Equipment

Position No.	Material	Order No.	Quantity
1	Solar battery, 4 cells, with cable and connectors	06752-22	1
2	Thermopile, Moll type	08479-00	1
3	Universal measuring amplifier	13626-93	1
4	Rheostat, 330 Ohm , 1.0A	06116-02	1
5	Ceramic lamp socket E27	06751-01	1
6	Filament lamp, 220V/120W, w.refl.	06759-93	1
7	Hot/cold air blower, 1800 W	04030-93	1
8	Meter scale, demo. l=1000mm	03001-00	1
9	Tripod base PHYWE	02002-55	2
10	Barrel base PHYWE	02006-55	2
11	Support rod PHYWE, square, l 250mm	02025-55	1
12	Right angle clamp PHYWE	02040-55	2
13	Plate holder	02062-00	1
14	Universal clamp	37715-00	2
15	Bench clamp PHYWE	02010-00	2
16	Glass pane, 150x100x4mm, 2off	35010-10	1
17	Digital multimeter 2005	07129-00	2
18	Lab thermometer, -10..+100 °C	38056-00	1
19	Connecting cord, 32 A, 500 mm, red	07361-01	3
20	Connecting cord, 32 A, 500 mm, blue	07361-04	2

Tasks

1. Measure the short-circuit current and no-load voltage at different light intensities and plot the current-voltage characteristic at different light intensities.
2. Estimate the dependence of no-load voltage and short-circuit current on temperature.
3. Plot the current-voltage characteristic under different operating conditions: cooling the equipment with a blower, no cooling, shining the light through a glass plate.
4. Determine the characteristic curve when illuminating by sunlight.

Set-up and procedure

- The thermopile only measures the light of the lamp but the solar cell also detects the diffused light coming from reflections on the bench top. Therefore, it is recommended to cover the bench with a black cloth or piece of black card to suppress the diffused light.
- The experimental set-up is as shown in Fig. 1. The glass plate is only needed for task 3.
- Do the electrical connections as in Fig. 2.

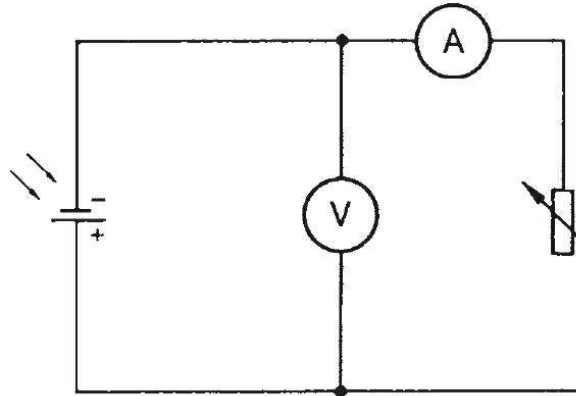

Fig. 2: Circuit for measuring the current-voltage characteristic.

Task 1

The light intensity is varied by varying the distance between the light source and the solar cell. First of all, measure the light intensity with the thermopile and amplifier with the equipment at different distances from the light source. (**Note:** the maximum output voltage of the amplifier is 10 V). The inlet aperture marks the position of the thermopile. The distance between the lamp and the thermopile should be at least 50 cm, since the angular aperture of the thermopile is only 20°.

To suppress the influence of the temperature on the characteristics of the solar cell, keep it at room temperature with the aid of the cold air blower during the experiment.

Task 2

To demonstrate the temperature effect, blow hot air over the solar cell and measure the temperature directly in front of it with a thermometer. Do not touch the cell as its thin p-layer can easily be damaged.

We recommend separating the lamp and solar cell more than 50 cm, because in shorter distances the temperature rise caused by radiation could falsify the measurement. Measure the no-load voltage and the short-circuit current.

Task 4

- The characteristics of the solar cell should be measured in sunlight also if possible; in this case both direct and diffused light are involved.
- The thermopile is used again to determine the relationship between the short-circuit current and the light intensity, although it measures only direct light because of its small angular aperture. For comparative purposes, therefore, we must support a black cardboard tube about 20 cm long in front of the solar cell to screen it from the diffused light. It is important that the thermopile and the solar cell are pointing directly into the sun.

Theory and evaluation

Pure silicon is deliberately "impurified" (doped) with tri- and pentavalent impurity atoms to make a p- or n-type semi-conductor. If we put a p- and n-type crystal together we get a junction (pn-junction, Fig. 3) whose electrical properties determine the performance of the solar cell.

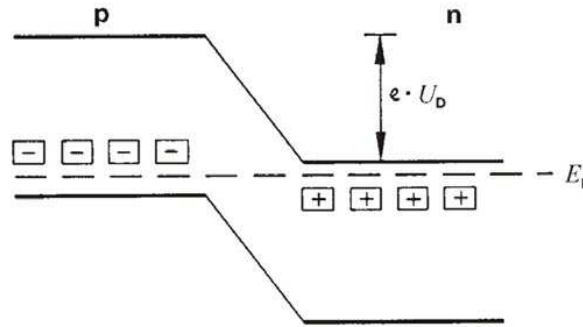

Fig. 3: pn-junction in the energy-band diagram - acceptors, + donors, U_D is the diffusion potential, E_F is the Fermi characteristic energy level, and e is the elementary charge.

In equilibrium (with no external voltage) the Fermi characteristic energy level E_F will be the same throughout. Because of the difference in the concentrations of electrons and holes in the p- and n-regions, electrons diffuse into the p-region and holes into the n-region. The immobile impurity atoms create a space charge-limited current region; the diffusion current and the field current offset one another in equilibrium.

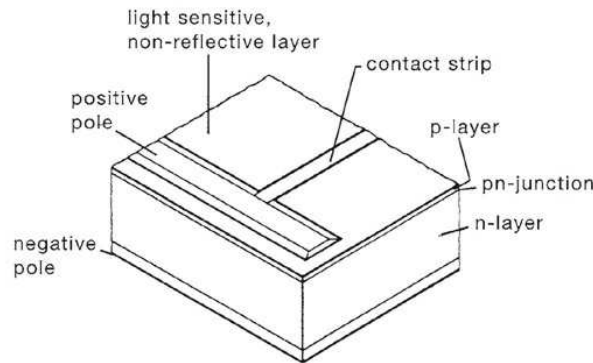

Fig. 4: Construction of a silicon solar cell.

The diffusion potential U_D in the pn-junction depends on the amount of doping and corresponds to the original difference between the Fermi energy levels of the separate p- and n-regions.

The distance between the valence band and the conduction band in silicon at room temperature is

$$E = 1.1 \text{ eV}$$

For silicon, the diffusion potential is

$$U_D = 0.5 \text{ to } 0.7 \text{ V.}$$

If light falls on the pn-junction, the photons create electronhole pairs separated by the space charge. The electrons are drawn into the n-region and the holes into the p-region. Photons are absorbed not only in the pn-junction but also in the p-layer above it. The electrons produced are minority carriers in those areas: their concentration is greatly reduced by recombination and with it their efficiency. The p-layer must therefore be sufficiently thin for the electrons of diffusion length L_E to enter the n-layer.

$$L_E \gg t$$

where t = thickness of p-layer.

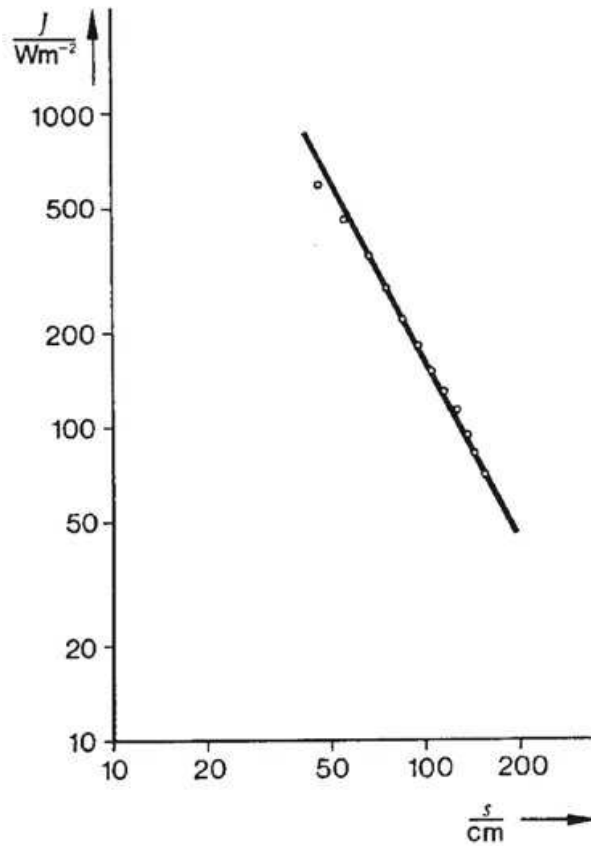

Fig. 5: Light intensity J at distances s normal to the light source.

If g is the number of electron-hole pairs produced per unit area and of a voltage U is applied across the pn-junction, a stream of electrons and holes of density

$$i = e \cdot (e^{eU/kT} - 1) \cdot \left(\frac{n_0 D_e t}{L^2 e} + \frac{p_0 D_h}{L_h} \right) - eg$$

is produced, where e is the elementary charge, k is Boltzmann's constant, T is the temperature, L is the diffusion length of electrons and holes, D is the diffusion constant for electrons and holes, n_0 and p_0 are equilibrium concentrations of the minority carriers.

The short-circuit current density ($U = 0$)

$$i_s = -e \cdot g$$

is proportional to the intensity of the incident light at fixed temperature. g becomes very slightly greater (less than 0.01 %/K) as the temperature rises.

The voltage U can become as high as the diffusion potential U_D but no higher. As the temperature rises the no-load voltage decreases typically by -2.3 mV/K, since the equilibrium concentrations n_0 and p_0 increase with the temperature:

$$n_0 \sim e^{-\Delta E/2kT}$$

Task 1:

For this task, it is assumed that all the light entering the aperture (dia. 2.5 cm) reaches the measuring surface. The sensitivity is 0.16 mV/mW. Plotting the light intensity J over the distance s gives a straight line. By extrapolating the straight line we can determine the intensity at distances $s \leq 50$ cm.

Fig. 6 shows the relationship between the light intensity and the short-circuit current and no-load voltage (Fig. 6).

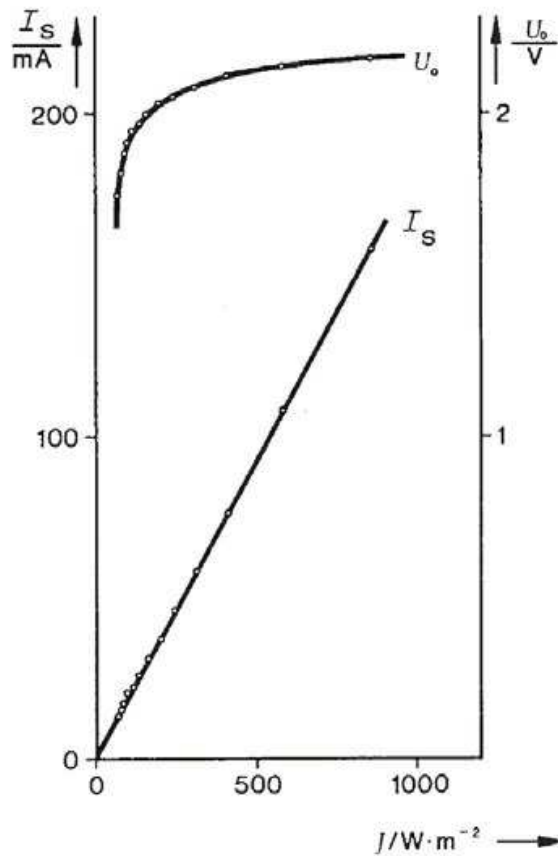

Fig. 6: Short-circuit current I_S and no-load voltage U_0 as a function of the light intensity J .

The solar battery which consists of four cells connected in series thus has a maximum no-load voltage of 2 V. The shortcircuit current is proportional to the light intensity.

$$I_S = 1.84 \cdot 10^{-4} \text{ A/Wm}^{-2} \cdot J$$

The current-voltage characteristic at different light intensities J is shown in Fig. 7. The maximum power output is at the turning points on the curves (joined by the broken line; Fig. 7) at which the load resistor has the same value as the internal resistance R_i of the solar battery.

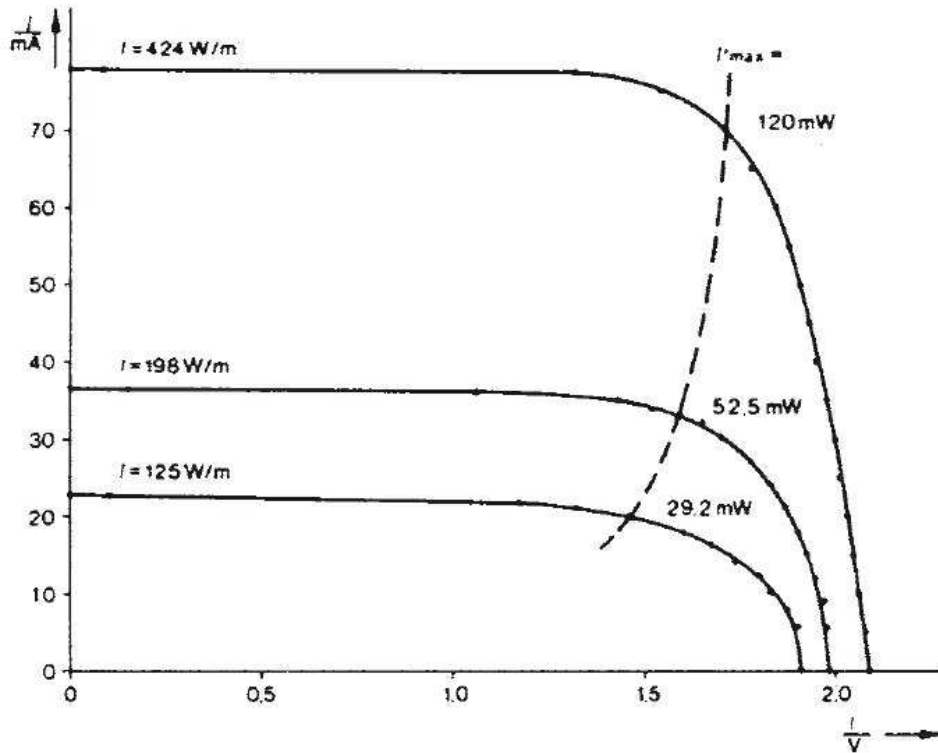

Fig. 7: Current-voltage characteristic at different light intensities J .

The internal resistance decreases with increasing light intensity. If we compare the maximum power output with the incident power, we obtain an efficiency of approx. 6% (area of solar battery 50 cm^2).

Task 2:

Measuring the effect of temperature on U_0 and I_S the temperature distribution over the hot air area must be taken into account. The measurements can provide only a rough order of magnitude of this. Measuring the no-load voltage with hot and cold air gave:

$$\frac{\Delta U_0}{\Delta T} = -8 \text{ mV/K}$$

We thus obtain the value -2 mV/K for one cell.

The change in short-circuit current with the temperature cannot be measured.

Task 3:

A glass plate which absorbs light in the infrared region can be used to reduce a rise in temperature of the solar battery. Fig. 8 shows the effect of the various 'operating modes'.

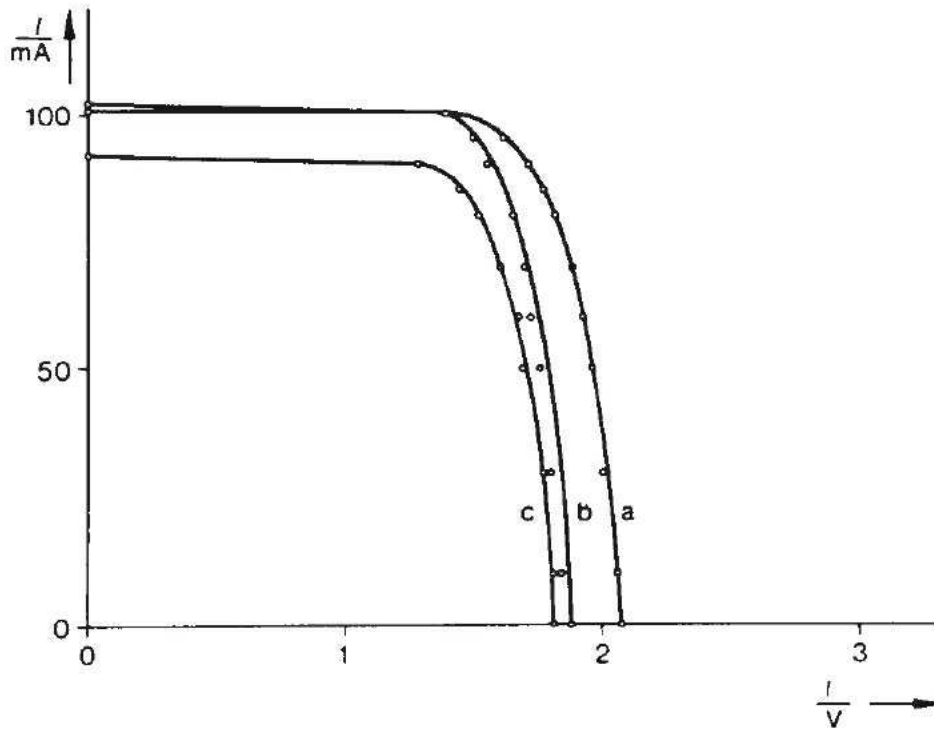

Fig. 8: Current-voltage characteristics of the solar battery a) with blower cooling b) with no blower cooling c) when screened with a glass plate.

Task 6:

Sunlight incident on solar cells produces different characteristic curves from incandescent light. The reason lies in the different spectra of the two light sources (Fig. 9). At the same light intensity, sunlight produces a higher shortcircuit current

$$I_s = 3.04 \cdot 10^{-4} \text{ JA/Wm}^{-2}$$

Because the infrared region of the spectrum of sunlight is smaller, the solar cell does not heat up so much and the measurements with and without cooling provide the same characteristics for sunlight.

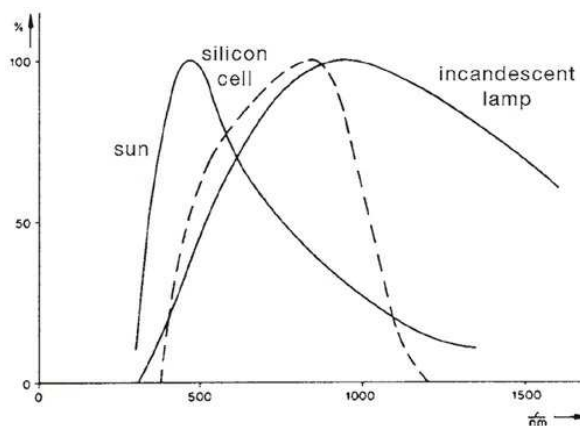

Fig. 9: Spectrum of the sun (T approx. 5800 K) and of an incandescent lamp (T approx. 2000 K), and the spectral sensitivity of the silicon solar cell.