

Fibre optics (Item No.: P2261000)

Curricular Relevance



Difficulty



Difficult

Preparation Time



10 Minutes

Execution Time



20 Minutes

Recommended Group Size



2 Students

Additional Requirements:

Experiment Variations:

Keywords:

Total reflection, Diodelaser, Gaussian beam, Monomode and multimode fibre, Numerical aperture, Transverse and longitudinal modes, Transit time, Threshold energy, Slope efficiency, Velocity of light

Principle and equipment

Principle

The beam of a laser diode is treated in a way that it can be coupled into a monomode fibre. The problems related to coupling the beam into the fibre are evaluated and verified. In consequence a low frequency signal is transmitted through the fibre. The numerical aperture of the fibre is recorded. The transit time of light through the fibre is measured and the velocity of light within the fibre is determined. Finally the measurement of the relative output power of the diodelaser as a function of the supply current leads to the characteristics of the diodelaser such as "threshold energy" and "slope efficiency".

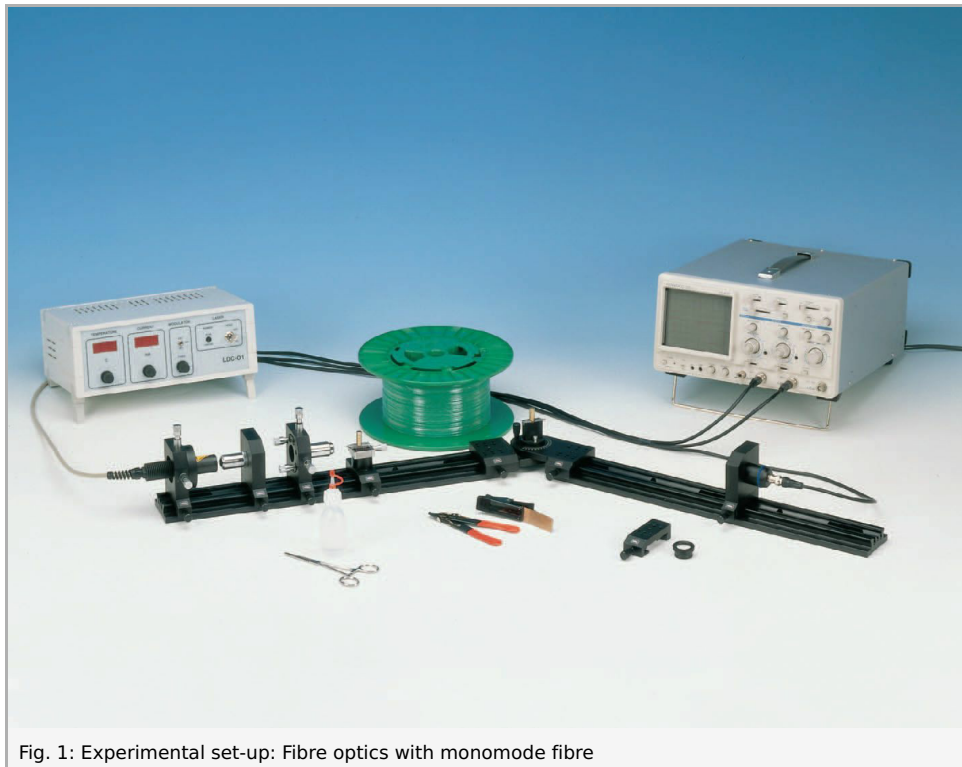

Fig. 1: Experimental set-up: Fibre optics with monomode fibre

Tasks

1. Couple the laser beam into the fibre and adjust the settingup in a way that a maximum of output power is achieved at the exit of the fibre.
2. Demonstrate the transmission of a LF - signal through the fibre.
3. Measure the numerical aperture of the fibre.
4. Measure the transit time of light through the fibre and determine the velocity of light within the fibre.
5. Determine the relative output power of the diodelaser as a function of the supply current.

Caution: Never look directly into a non attenuated laser beam!

Equipment

Position No.	Material	Order No.	Quantity
1	Screened cable, BNC, l = 750 mm	07542-11	2
2	Digital Storage Oszilloscope 200 MHz, 2 Gs/s	11453-99	1
3	Experimental set Fibre optics	08662-93	1

Set-up and procedure

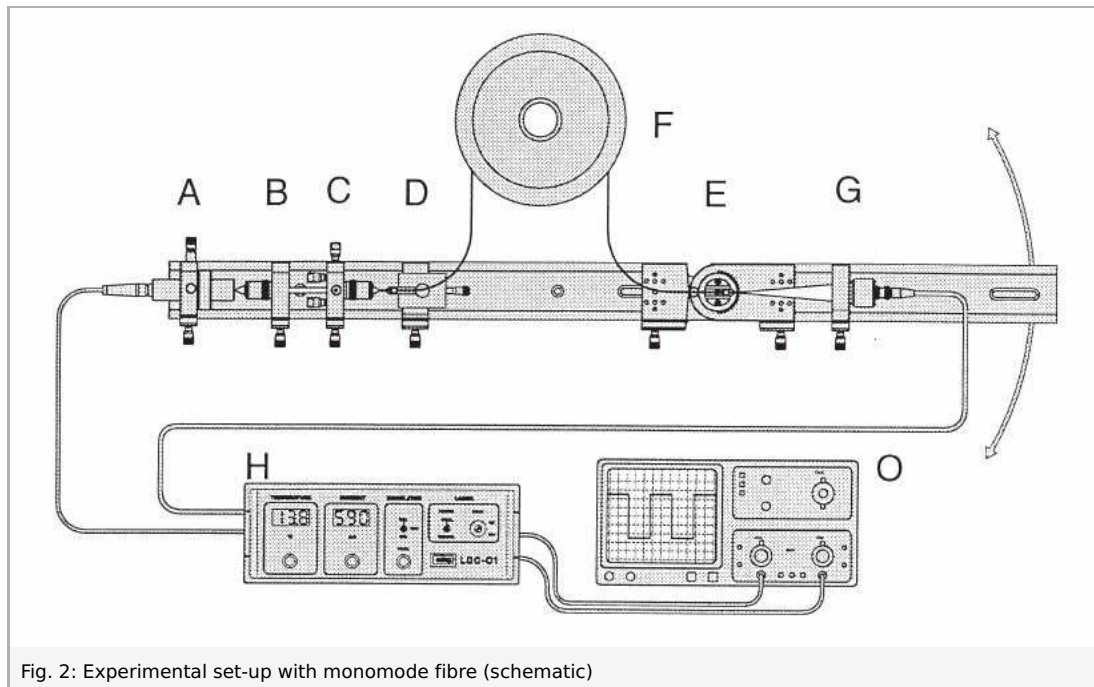

Fig. 2: Experimental set-up with monomode fibre (schematic)

This set-up has been made with a monomode fibre.
The connection of the fibre with module D is done in the following way:

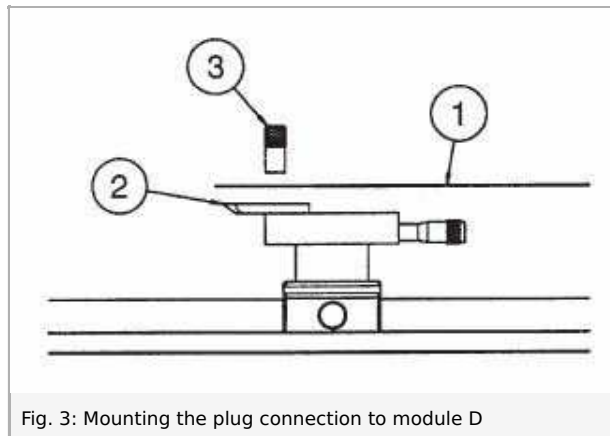

Fig. 3: Mounting the plug connection to module D

After eliminating the insulation from both fibre ends by scratching, the cut and cleaved fibre (1) is to put into the groove of holder (2) and carefully fixed with the magnet (3).

- **Module A:** The laser diode in its housing is mounted on a XYfine adjustment. A Peltier cooler and a thermistor for measuring the laser diode temperature are incorporated in the housing. The laser diode emits a maximum power of 50 mW.
- **Module B:** A microscope objective collimates the laser diode radiation. The objective is screwed into the mounting plate that it can easily be removed from the plate holder and exchanged for another one. Before we start with the measurements we have to define the optical axis of the set-up. This is done with the help of an oscilloscope. The injection current is modulated so that we can see rectangular pulses on the oscilloscope. The collimator (Module B) is brought at such a position to the laser diode that a nearly parallel laser beam is formed. By means of the XY-displacement screws of Module A the laser beam is then centralised on the detector. This can be checked by looking for the maximum signal on the oscilloscope. Precaution has to be taken that the detector does not reach saturation. Eventually the injection current has to be reduced by a suitable amount. The next step is to bring the coupling optics (Module C) into the set-up.
- **Module C:** Basically the same arrangement as Module B but with a fine adjustment holder with four axis XY, Θ and Φ and an objective of smaller focal distance to focus the collimated laser diode radiation in such a way that an effective coupling to the fibre is ensured. A beam shaping of the laser diode radiation has purposely been omitted to simplify the entrance into the experiment.
- **Module D:** Before starting the experiment the prepared fibre is mounted to the Module D. The fibre holder is mounted on a stage with linear displacement in the direction of the beam.
- **Module F:** 100 m monomode fibre are coiled up on a drum. Of course multimode fibres can also be used, which make alignment much easier.
- **Module E:** On a hinged joined angle connector the second fibre holder is mounted, but without a linear stage. This device allows the measurement of the angle dependent output power of the fibre.
- **Module G:** This module consists of the detector with a PIN photodiode. The connection to the preamplifier of the control unit LDC01 is made by a BNC cable. The inner pin of the BNC plug is in contact with the anode of the photodetector.

Theory and evaluation

One essential desire of human beings is to use information faster than others for their own benefit. In his publication "Die Quasioptik der Ultrakurzwellenleiter" H. Buchholz expressed in 1939 the idea to guide light signals along light - conducting material and to use them for data transmission. But only with the development of the semiconductor laser in 1962 was Buchholz' idea materialised by using just these lasers and fibres as a light transmitting medium. Suddenly, simple and powerful light sources for the generation and modulation of light were available. Today the transmission of signals using laser diodes and fibres has become an indispensable technology and the on-going development in this area is one of the most important within this century. Following the achievements of communication technology, the development of fibre optical sensors began in 1977. Here the laser gyroscope for navigation has to be emphasised in particular. This new technology is based on well known fundamentals in a way that no new understanding has to be created. Still, there is a challenge with respect to the technical realisation, keeping in mind that the light has to be guided within fibres of only 5 μm diameter. Appropriate fibres had to be developed and mechanical components of high precision had to be developed for coupling the light to the conductor (fibre) and for the installation of the fibres. Further goals are the reduction of transmission losses, optical amplification within the fibre as a replacement of the electronic amplifiers and laser diodes of small band width to increase the transmission speed of signals.

There is hardly any book in optics which does not contain the experiment of Colladan (1861) on total reflection of light. Most of us may have enjoyed it during the basic physics course.

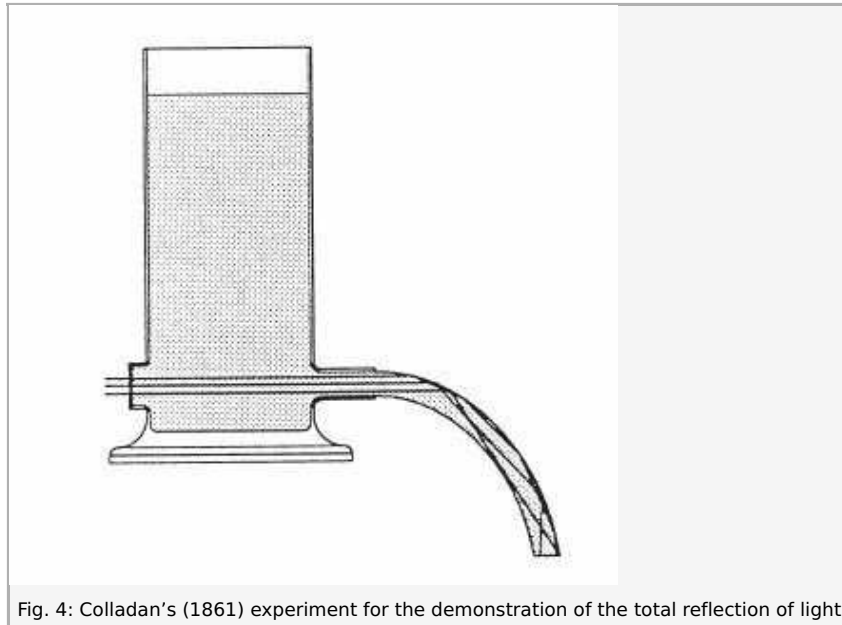

Fig. 4: Colladan's (1861) experiment for the demonstration of the total reflection of light

An intensive light beam is introduced into the axis of an outflowing water jet. Because of repeated total reflections the light can not leave the jet and it is forced to follow the water jet. It is expected that the jet remains completely dark unless the surface contains small disturbances. This leads to a certain loss of light and it appears illuminated all along its path. Effects of light created in this way are also known as "Fontaines lumineuses". They generally please the onlookers of water fountains. This historical experiment already shows the physical phenomena which are basic in fibre optics. If we designate the diameter of a light guide with d we can state:

"Fontaines lumineuses" $d \gg \lambda$

Multimode fibre $d > \lambda$

Monomode fibre $d = \lambda$

For the fibres manufactured these days, this leads to further effects which can not be described exclusively by total reflection. Their understanding is of special importance for optical communication technology. In the manual, we deduce these effects based on Maxwell's equations. For the work in fibre optics it is not compulsory to know this formalism. It is sufficient to familiarise oneself with the results. Nevertheless a few remarks are to be made with regard to the analytical formalism.

Within the frame of further considerations we will refer to fibres as light conductors which are made of glass or similar matter. They have no electric conductivity, no free charge carriers and no magnetic dipoles. Therefore the Maxwell equations adapted to our problem are as follows:

$$\begin{aligned} \nabla_x \vec{H} &= \epsilon \cdot \epsilon_0 \cdot \frac{\delta \vec{E}}{\delta t} \text{ and } \nabla_x \vec{H} = 0 \\ \nabla_x \vec{E} &= \frac{\delta \vec{H}}{\delta t} \text{ and } \nabla_x \vec{E} = 0 \end{aligned}$$

ϵ_0 is the dielectric constant of the free space. It represents the ratio of the unit charge (As) to unit field strength (V/m) and amounts to $8.859 \cdot 10^{-12}$ As/Vm. ϵ is the dielectric constant of matter. It characterises the degree of extension of an electric dipole acted on by an external electric field \vec{E} . The dielectric constant ϵ and the susceptibility χ are linked by the following relation:

$$\epsilon = \frac{1}{\epsilon_0} \cdot (\chi + \epsilon_0)$$

The product $\epsilon \cdot \epsilon_0 \cdot \vec{R} = \vec{D}$

is therefore called "dielectric displacement" or displacement. ϵ_0 is the absolute permeability of the free space. It gives the context between the unit of an induced voltage (V) due to the presence of a magnetic field \vec{H} of unit Am/s. It amounts to $1.256 \cdot 10^{-6}$ Vs/Am.

Using the above equations, the goal of the following calculations will be to get an appropriate set of equations describing the propagation of light in glass or similar matter. After this step we will introduce the boundary conditions which have to be implemented due to the use of fibre glass with cladding. For details please refer to the manual.

Glass fibres as wave conductors have a circular cross section. They consist of a core of refractive index n_k . The core is

surrounded by a glass cladding of refractive index n_m slightly lower than n_k . Generally the refractive index of the core as well as the refractive index of the cladding are considered homogeneously distributed. The boundary is between core and cladding. The final direction of the beam is defined by the angle Θ_e under which the beam enters the fibre. Unintended but not always avoidable radiation and cladding waves are generated in this way. For reasons of mechanical protection and absorption of the radiation waves, the fibre is surrounded by a protective layer.

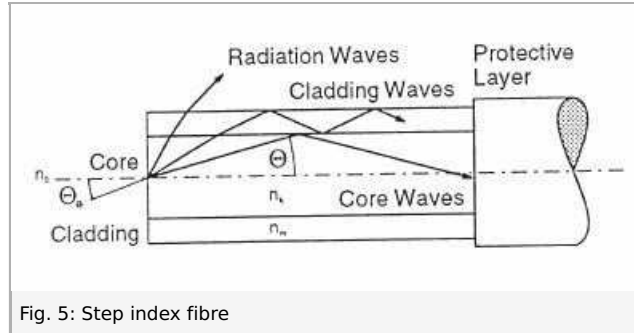

Fig. 5: Step index fibre

Fig. 5 reveals some basic facts which can be seen without having solved Maxwell's equations. Starting from geometrical considerations we can state that there must be a limiting angle Θ_c for total reflection at the boundary between cladding and core.

$$\cos(\Theta_c) = \frac{n_m}{n_k}$$

For the angle of incidence of the fibre we use the law of refraction:

$$\frac{\sin(\Theta_{ec})}{\sin(\Theta_c)} = \frac{n_k}{n_0}$$

and obtain:

$$\Theta_{ec} = \arcsin\left(\frac{n_k}{n_0} \cdot \sin(\Theta_c)\right).$$

Using the above equation and with $n_0 = 1$ for air we finally get:

$$\Theta_{ec} = \arcsin\left(\sqrt{n_k^2 - n_m^2}\right).$$

The limiting angle Θ_{ec} represents half the opening angle of a cone. All beams entering this cone will be guided into core by total reflection. As usual in optics here, too, we can define a numerical aperture A :

$$A = \sin(\Theta_{ec}) = \sqrt{n_k^2 - n_m^2}$$

Depending under which angle the beams enter the cylindrical core through the cone they propagate in a screw. This becomes evident if we project the beam displacements onto the XY-plane of the fibre. The direction along the fibre is considered as the direction of the z -axis. A periodical pattern is recognised. It can be interpreted as standing waves in the XYplane. In this context the standing waves are called oscillating modes or simply modes. Since these modes are built up in the XY-plane, e. g. perpendicularly to the z -axis, they are also called transverse modes. Modes built up along the z -axis are called longitudinal modes.

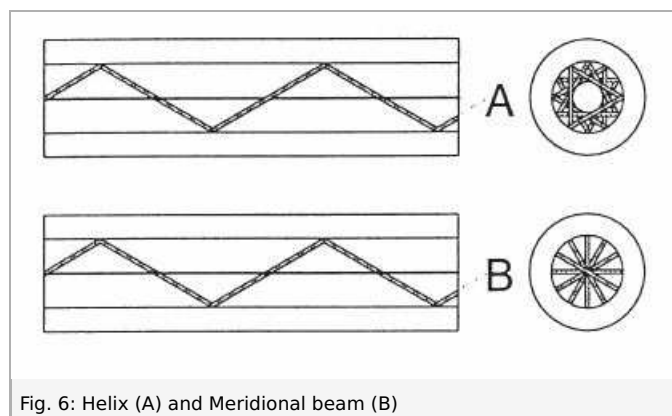

Fig. 6: Helix (A) and Meridional beam (B)

The Bessel function is a suitable solution for the core. For the cladding we need, in addition, an attenuation of the field. Here the modified Hankel function offers a promising solution. For $x \rightarrow 0$ and $r \rightarrow 0$ it turns to infinity but we only need it for the range $r \leq a$ (cladding).

For the range $r \geq a$ (core) we shall use the Bessel function. For solving the problems at the boundary between core and cladding we shall use the continuity conditions of the components of \mathbf{E} and \mathbf{H} for the transition from core to cladding and fit the Bessel and Hankel function for $r = a$.

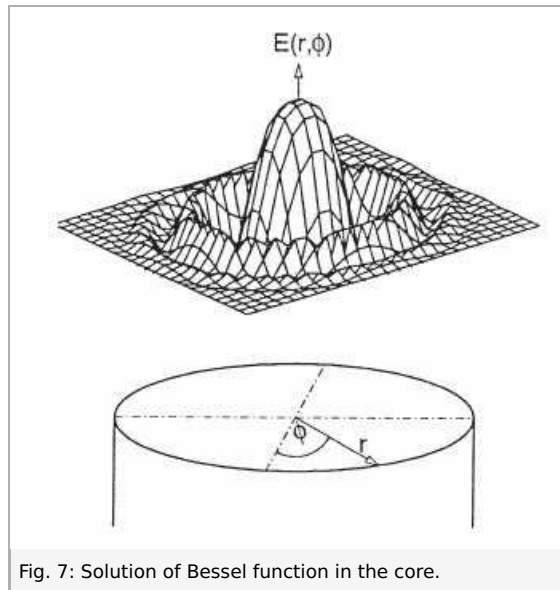

Fig. 7: Solution of Bessel function in the core.

Fig. 7 presents one solution in the core. We now see how the electric field will establish within the core. It also becomes clear that the radius of the fibre will be decisive for the order of the modes. In the radial direction of the fibre we observe a main maximum at $r = 0$ and, further aside, maxima or minima which are also called nodes. The number of nodes is determined by the diameter of the fibre as well as by the solution of the wave equation within the cladding. After having chosen a suitable cylindrical function for the solution within the cladding, it has to be ensured that it matches the continuity conditions for the electric and magnetic field at the boundary between core and cladding. This leads to the complete solution. For the waves within the cladding, $r \geq a$, we want to achieve that the radial field of the core rapidly decreases in the cladding to favour the guidance of waves within the core. If the fibre is made in a way that only the fundamental wave is guided within the core the fibre is called a monomode or singlemode fibre. In all other cases we speak about a multimode fibre. Depending on the range of application of the fibre one uses one or the other type of fibre. Let's now derive the "construction"-rule for a fibre from the solutions allowing us to define the conditions under which a fibre "accepts" an incoming wave at given wavelength and guides it as a monomode fibre. The condition for the transmission of the fundamental wave exclusively is (see manual):

$$0 < \frac{2\pi}{\lambda} a \sqrt{n_k^2 - n_m^2} \leq 2.405$$

The above equation represents an important prescription for the design of the fibre. It fixes the radius a of the core for monomode waveguidance if the wavelength λ and the refractive index for cladding and core have been selected. If, for example, the problem would be to transmit the light of a Helium-Neon laser (wavelength 633 nm, refractive index of cladding 1.4) we would get the following range for the radius a :

$$a < 2.405 \cdot \frac{633 \cdot 10^{-9}}{2\pi \sqrt{(1.5)^2 - (1.4)^2}} = 0.45 \mu m$$

The result depends strongly on the difference of the refractive index. The smaller this difference the greater can be the radius a . Still, because of technical reasons it is not possible to choose the refractive index of the core much larger than the refractive index of the cladding. Since core and cladding are in close contact glasses of similar temperature coefficient can only be used. The consequence of this is the small difference in refractive index. For ordinary fibres it is

$$\frac{n_k - n_m}{n_k} = 2 \cdot 10^{-3}$$

where the refractive index n_k of the core is equal to 1.465. If we use these values for the above mentioned example we get:

$$0 < a < 2.405 \cdot \frac{633 \cdot 10^{-9}}{2\pi \sqrt{(1.5)^2 - (1.4)^2}} = 0.45 \mu m$$

The diameter of the fibre should be chosen smaller than $5.2 \mu m$ to get the desired monomode transmission. We are facing the problem to couple a beam of light to a fibre, respectively to introduce it into fibre, the diameter of which is in the order of

magnitude of 4–10 μm and in so far comparable to the wavelength of light. To get a sufficient high excitation of the fundamental mode of the fibre, the beam of the light source has to be focused to a diameter of this order of magnitude. Under these circumstances the laws of geometrical optics fail because they anticipate parallel light beams or plane light waves which in reality exist only in approximation.

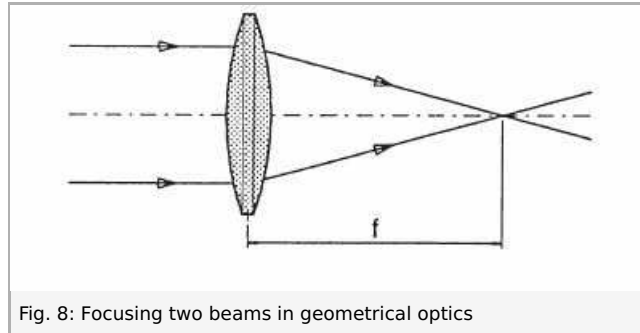

Fig. 8: Focusing two beams in geometrical optics

Real parallel light beams do not exist in reality and plane wave fronts exist only at a particular point. The reason for the failure of geometrical optics is the fact that it has been defined at a time where the wave character of light was still as unknown as the possibility to describe its behaviour by Maxwell's equations. To describe the propagation of light we use the wave equation

$$\Delta \vec{E} - \frac{n^2}{c^2} \cdot \frac{\delta \vec{E}}{\delta t^2} = 0$$

Solving this equation for the fibre we anticipated waves propagating within the fibre as a cylindrical body

$$\vec{E} = \vec{E}(r, \Theta, z) \text{ with } r^2 = x^2 + y^2$$

Without a boundary, light would propagate as a spherical wave in all directions of the space.

$$\vec{E} = \vec{E}(r) \text{ with } r^2 = x^2 + y^2 + z^2$$

When we consider the technically most important case of spherical waves propagating in the direction of z within a small solid angle, we arrive at the following statement for the electrical field:

$$\vec{E} = \vec{E}(r, z) \text{ with } r^2 = x^2 + y^2$$

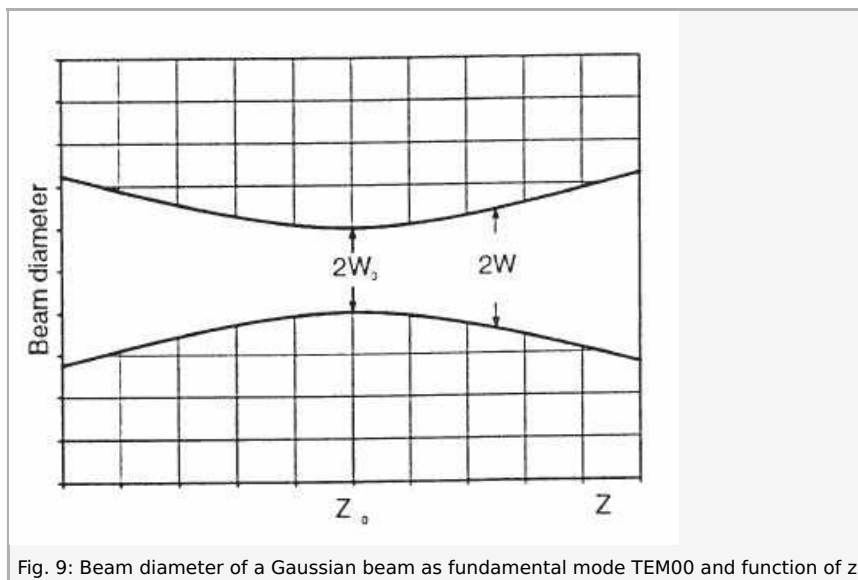

Fig. 9: Beam diameter of a Gaussian beam as fundamental mode TEM₀₀ and function of z

In this case the solution of the wave equation provides fields which have a Gaussian intensity distribution over the crosssection. Therefore they are called Gaussian beams. Similar to the solutions of the fibre the Gaussian beams exist in different modes depending on the actual boundary conditions. Such beams, especially the Gaussian fundamental mode (TEM₀₀) are generated with preference by lasers. But the light of any light source can be considered as the superposition of many such Gaussian modes. Still, the intensity of a particular mode is small with respect to the total intensity of the light source. The situation is different for the laser. Here the total light power can be concentrated in the fundamental mode. This is the most outstanding difference with respect to ordinary light sources next to the monochromasy of laser radiation. Gaussian beams behave

differently from geometrical beams:

A Gaussian beam always has a waist. The beam radius ω results out of the wave equation as follows:

$$\omega(z) = \omega_0 \cdot \sqrt{1 + \left(\frac{z}{z_r}\right)^2}$$

ω_0 is the smallest beam radius at the waist and z_r is the Rayleigh length

$$z_r = \omega_0^2 \frac{\pi}{\lambda}$$

In Fig. 9 the course of the beam diameter as a function of z is represented. The beam propagates within the direction of z . At the position $z = z_0$ the beam has the smallest radius. The beam radius increases linearly with increasing distance. Since Gaussian beams are spherical waves we can attribute a radius of curvature of the wave field to each point z . The radius of curvature R can be calculated using the following relation:

$$R(z) = z + \frac{z_r^2}{z}$$

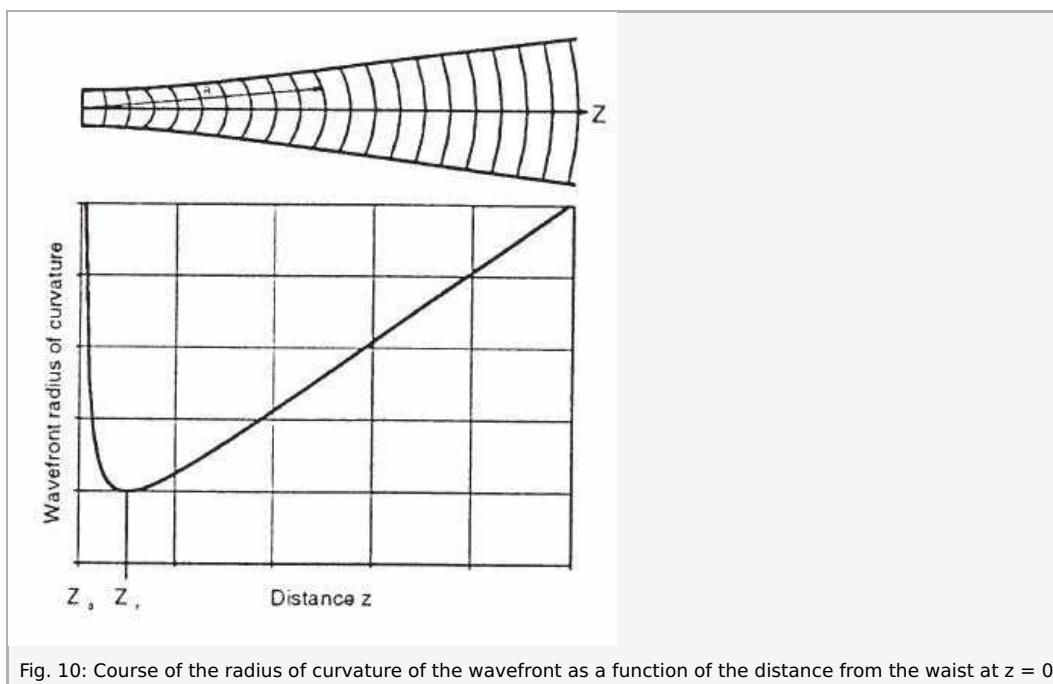

Fig. 10: Course of the radius of curvature of the wavefront as a function of the distance from the waist at $z = 0$

This context is reflected by Fig. 10. At $z = z_r$ the radius of curvature has a minimum. Then R increases with $1/z$ if z tends to $z = 0$. For $z = 0$ the radius of curvature is infinite. Here the wavefront is plane. Above the Rayleigh length z_r the radius of curvature increases linearly. This is a very essential statement. Due to this statement a parallel beam only exists at one point of the light wave, to be precise only in its focus. Within the range

$$-z_r \leq z \leq z_r$$

a beam can be considered as parallel or collimated in good approximation. In Fig. 11 the Rayleigh range has been marked as well as the divergence Θ in the farfield, that means for $z \gg z_0$. The graphical representations do not well inform you about the extremely small divergence of laser beams which is another outstanding property of lasers.

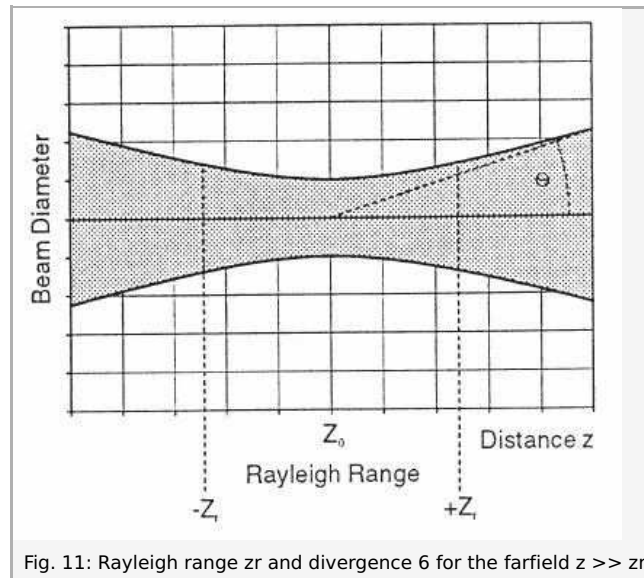

Fig. 11: Rayleigh range z_r and divergence θ for the farfield $z \gg z_r$

The reason for this is that the ratio of the beam diameter with regard to z has not been normalised. Let's consider, for example, a He-Ne laser (632 nm) with a beam radius of $w_0 = 1\text{mm}$ at the exit of the laser. For the Rayleigh range $2z_r$ we get:

$$2z_r = 2w_0^2 \frac{\pi}{\lambda} = 2 \cdot 10^{-6} \frac{3.14}{623 \cdot 10^{-9}} = 9.9\text{m}$$

To get a maximum of power into the fibre a coupling optic of focal distance f is required assuring the coupling of a Gaussian beam into a weak guiding step index fibre in the fundamental mode.

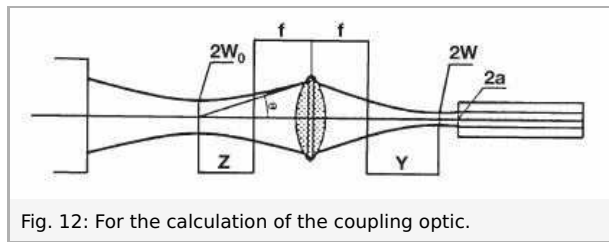

Fig. 12: For the calculation of the coupling optic.

The radius at the waist is

$$\omega = \frac{\omega_0 \cdot f \cdot \theta}{\sqrt{\omega_0^2 + \theta^2 \cdot z^2}}$$

The position of the waist is

$$y = \frac{z \cdot f^2}{z^2 + \left(\frac{\omega_0}{\theta}\right)^2}$$

Example: The beam of a He-Ne laser of 0.5 mm diameter and of 1.5 mrad divergence is made to focus by means of a lens. The focal distance is 50 mm and the lens is at a distance of 2 m from the laser. We find:

$$\omega = \frac{0.5 \cdot 10^{-3} \cdot 0.05 \cdot 1.5 \cdot 10^{-3}}{\sqrt{0.25 \cdot 10^{-6} + 2.25 \cdot 10^{-6} \cdot (2 - 0.05)^2}} = 12.6 \mu\text{m}$$

$$y = \frac{(2 - 0.05) \cdot 2.5 \cdot 10^{-6}}{(2 - 0.05)^2 + \left(\frac{0.5}{1.5}\right)^2} = 1.25 \mu\text{m}$$

For this example the position y of the waist coincides with the focus in good approximation and the radius of the waist is here 12.6 μm . To get the fibre under consideration adapted in an optimal way, the focal distance f has to be chosen in a way that the radius of the beam is equal to the radius of the core. When laser diodes are used, the preparation of the beam becomes more complicated.

1. For coupling the diodelaser beam into the fibre, the beam is first collimated by means of Module B. The distance of Module C to Module B is more or less arbitrary since the laser beam is nearly parallel. 50 mm are recommended. Now the fibre adjustment holder (Module D without fibre) is put on the rail at a distance of about 10 mm from Module C. The fibre is then carefully mounted to the fibre adjustment holder and inserted. The laser diode is switched to maximum injection current and the internal

modulation is "on". The detector is fixed to the holder plate G in front of the fibre exit. If the amplifier of the control unit and the oscilloscope are set to highest amplification, one already detects modulated laser light at the exit of the fibre. Now the fibre has to be adjusted. While observing the amplitude on the oscilloscope one turns gently the XY and $\Theta\Phi$ adjustment screws of the adjustment holder. If there is no further increase in the amplitude the distance between fibre and coupling optics will be changed by acting on the linear displacement of the sliding mount. In the new position the adjustment screws are readjusted. Since the amplitude increases continuously the amplification of the oscilloscope has to be reduced accordingly. At a certain state of adjustment the injection current has to be reduced since meanwhile so much power is coupled to the fibre that the detector approaches saturation. By means of the IR conversion card one can now observe the outgoing radiation if the room is sufficiently darkened. The previous adjustment steps are repeated until no further power increase is observed. The set-up is now well prepared for the following measurements.

2. The control unit LDC01 has a modulation input to which a signal generator can be connected. That way the injection current can be modulated by any type of LF - signal. The signal generator should have an adjustable off-set to get the working point in the midst of the characteristic line of the laserdiode. Any source of signals can be used as a signal generator, also sources of digital signals, provided they have the required input voltage level.

3. The holder G with the PIN photodiode is positioned on the right rail at a distance not too far from holder E predetermined by the rotation joint. The output power of the fibre is measured for different angles from -10 to +10 degree. We use modulated light to eliminate the influence of environmental disturbances. The amplitudes are proportional to the light intensity. Fig. 13 shows the relative output power versus angle readout. Because of tolerances in the fibre's position the curve is not symmetrical about the angle readout of 0 degree. For - 4.5 respectively +6.8 degree the intensity has fallen to $1/e^2$ of its maximum value, i. e. the numerical aperture is found to be:

$$\sin 5.65^\circ = 0.098$$

Starting from the refractive indices of core and cladding (1.465 and 1.462) results in a limiting angle for the incident beam of 5.3° . Thus the theoretical value of the numerical aperture A is expected to be $\sin 5.3^\circ = 0.092$. The measured value is in acceptable agreement with the theoretical one.

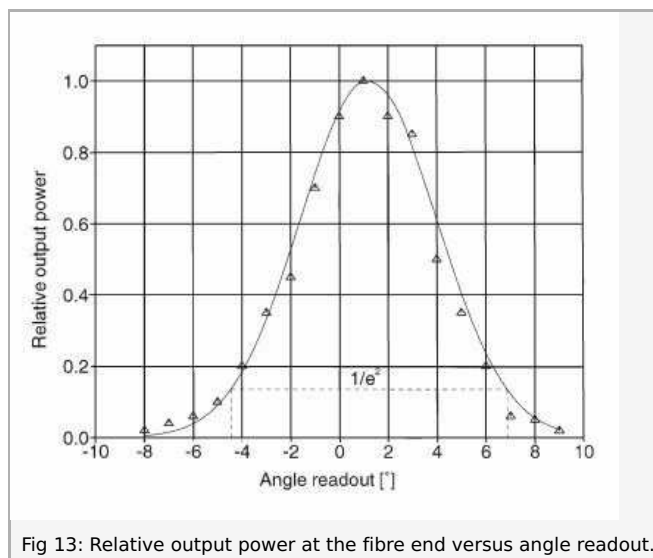

4. Another very interesting experiment is the measurement of the transit time of light through the fibre. The set-up is modified so that the detector is again next to the end of the fibre in holder G. The detector is connected directly to the oscilloscope of 100 MHz. To reduce the rise time of the signal a 50 Ω resistor is used as shunt. The second channel is connected to the monitor exit of the injection current at the control unit LDC01. For an appropriate set of time base one gets curve A on the second channel.

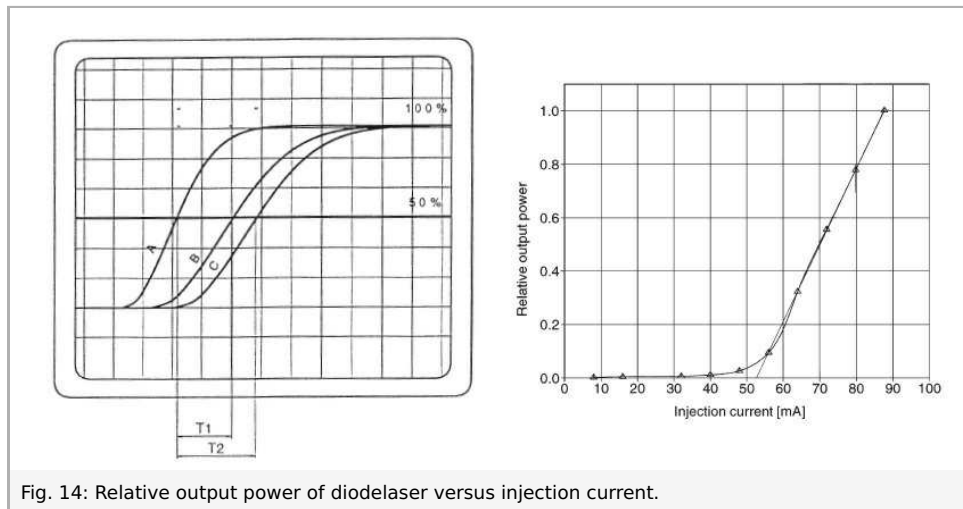

Fig. 14: Relative output power of diodelaser versus injection current.

The fibre is now eliminated from the set-up by taking off the mounted plug connections from the holders. (Attention! Put the fibre ends in a safe place) Curve B is represented on the first channel and the time difference T_1 at 50 % of the rise time is measured. The time T_1 represents all transit time delays of the system without fibre. Then the fibre is reinserted and adjusted to maximum power. Next we are going to find curve C and time T_2 . The time T_2 contains the transit time delays of the system and the transit time of the light through the fibre. The order of magnitude of the transit time through the fibre of 100 m length can be estimated as follows:

$$\tau_{\text{light}} = \frac{L}{c} \cdot n_{\text{eff}} = \frac{100}{3 \cdot 10^8} \cdot 1.45 \approx 0.5 \mu\text{s}$$

$$\tau_{\text{light}} = (0.15 - 0.7) \mu\text{s} = 0.45 \mu\text{s}$$

It was found by measurement:

And for the velocity of light within the fibre we get:

$$v_{\text{light, calculated}} = 100 / 0.5 \cdot 10^6 \text{ (m/s)} = 2 \cdot 10^8 \text{ (m/s)}$$

and

$$v_{\text{light, measured}} = 100 / 0.45 \cdot 10^6 \text{ (m/s)} = 2.2 \cdot 10^8 \text{ (m/s)}$$

5. The PIN photodiode is now placed at a distance of 2 cm in front of the diodelaser. The supply current of the diodelaser is modulated internally. After ensuring that the photodiode is not saturated the relative output power of the diodelaser is measured for increasing values of the supply current. Fig. 14 summarises the results of the measurements. It becomes evident that there is a threshold current needed to get a laser radiation output at all. Beyond this threshold current the output power increases linearly with the supply current. From the slope of the curve the so called "slope efficiency" of the diodelaser can be determined.